

Programvareløsning for trapp i industriell håndverk og industri

New Dimension

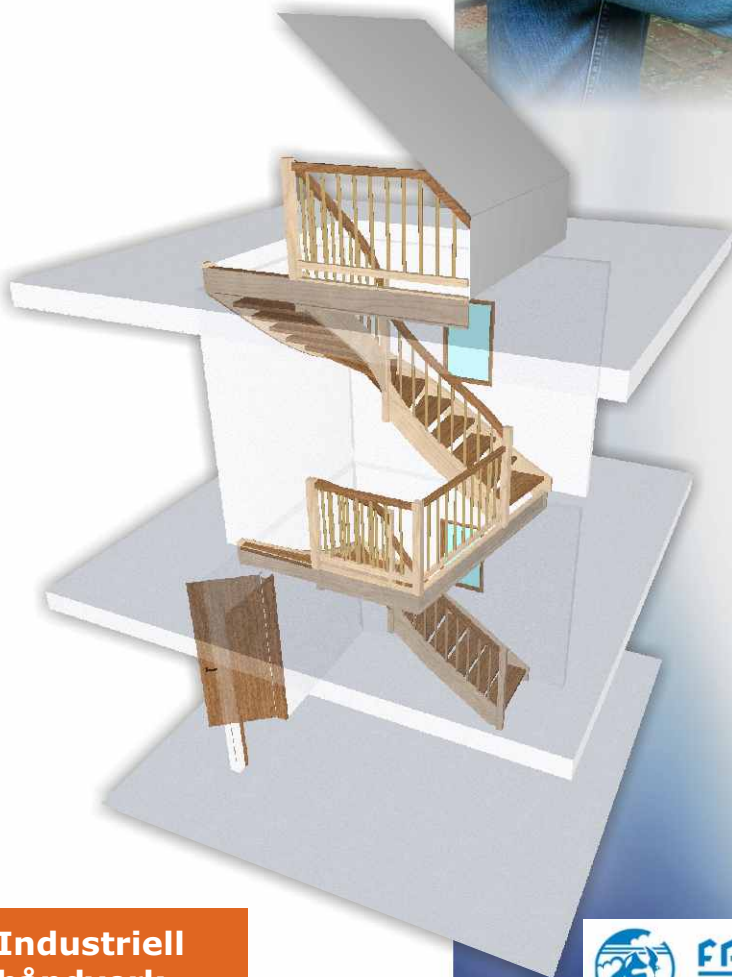
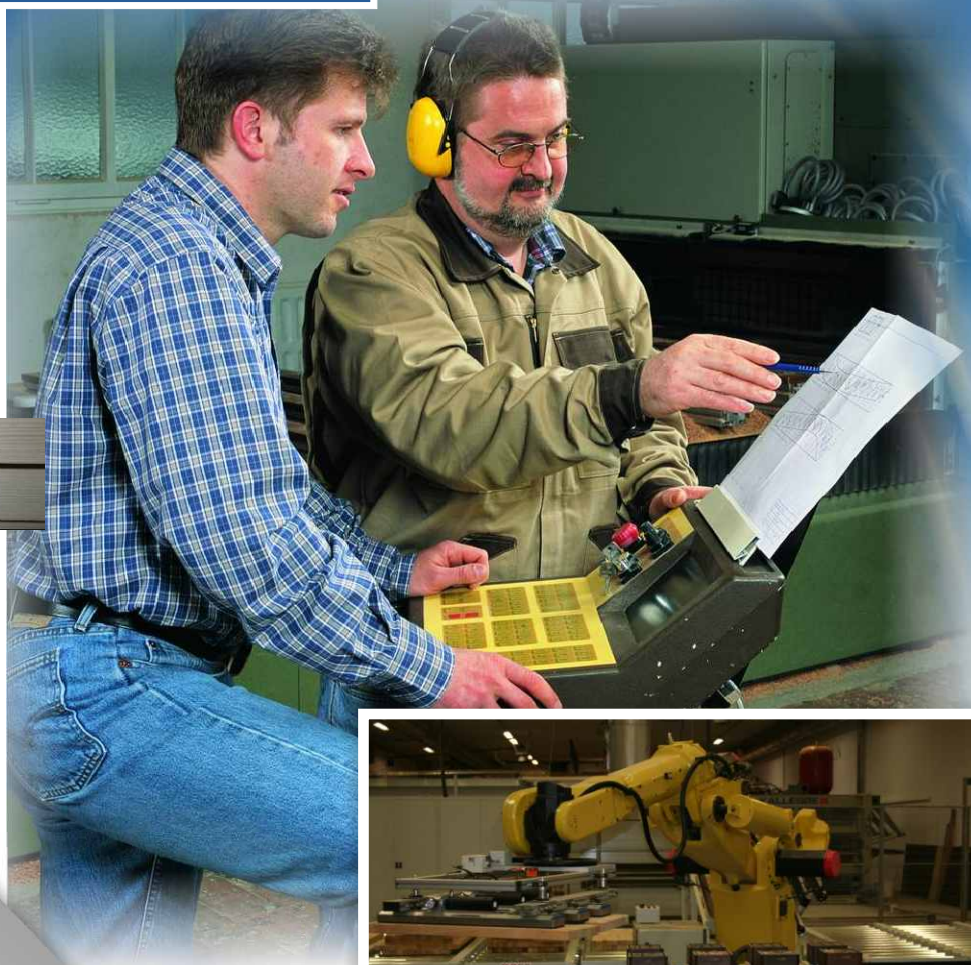
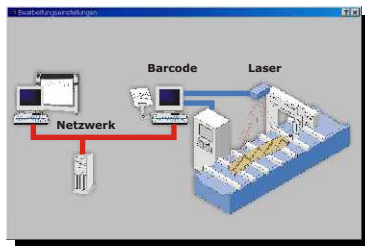
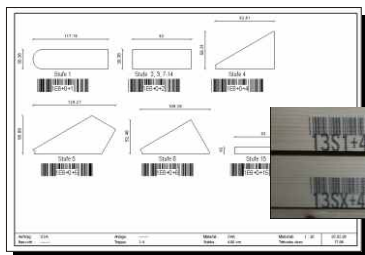
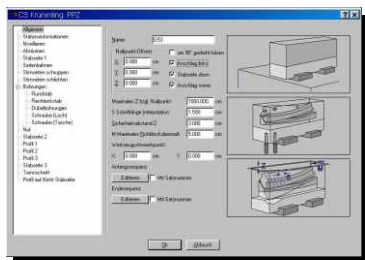

- Automatisk generering av alle CNC-informasjon
- 3-aks-, 4-aks- og 5-aks-bearbeiding av alle trappedeler
- Integrasjon av barcode, driver og styring for laser og/eller automatisk posisjonering av bordet (sugekopper eller klemmer), nesting, automatisk mating med robotinformasjon

Industriell håndverk



FALKENBERG
- mer enn maskiner!

Compass Software



Programvareløsning for trapp i håndverk

New Dimension

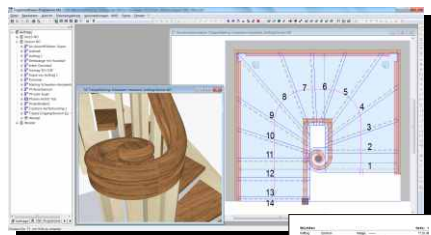

Part	Material	Quantity
1	Stige	12
2	Stige	12
3	Stige	12
4	Stige	12
5	Stige	12
6	Stige	12
7	Stige	12
8	Stige	12
9	Stige	12
10	Stige	12
11	Stige	12
12	Stige	12
13	Stige	12
14	Stige	12

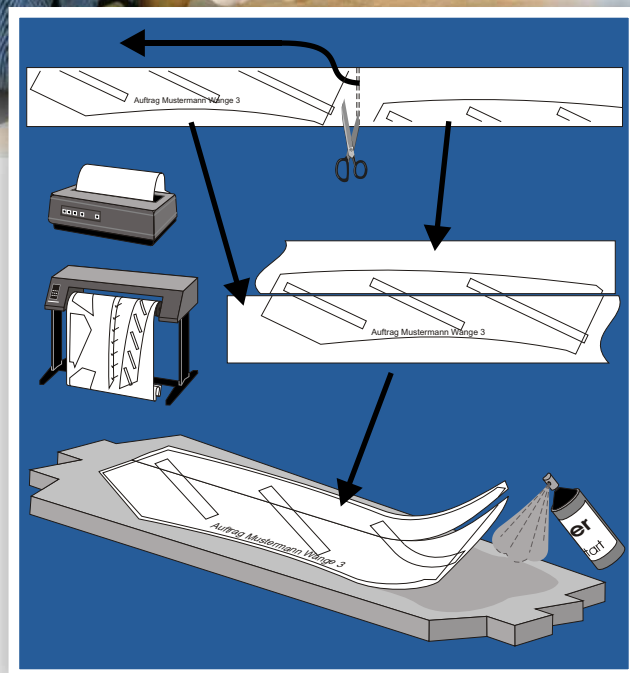
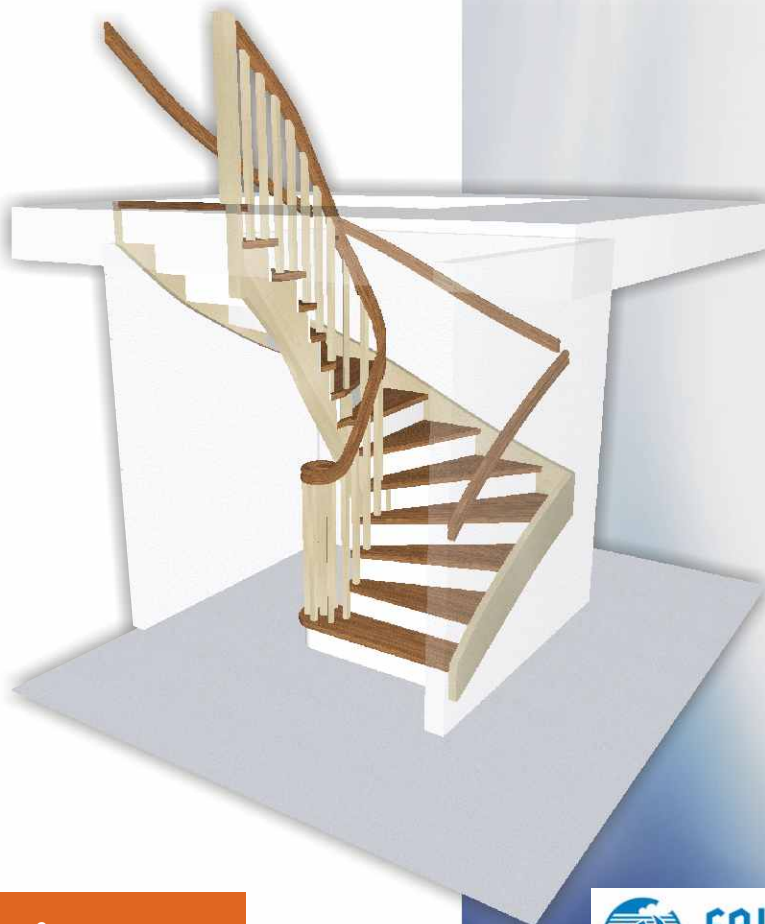
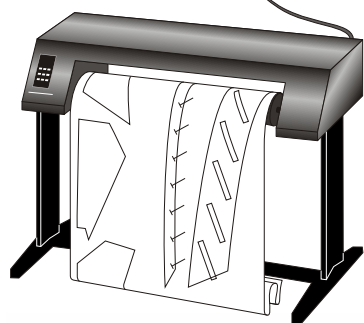
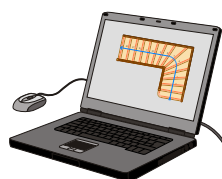
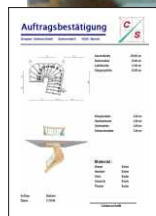

- Enkel og fri konstruksjon av trapper med tegninger for kunde og 3D-visning
- Utgave av alle produksjonsinformasjoner i delelister og 1:1-sjabloner
- Rimelig startmuligheter

Håndverk



Compass Software

